

仅供参考

REV.	REVISION RECORD	DATE
A0	新图面发行	2017.06.16

Specification:
 Current Rating : 2AMP
 Temperature Range : -40°C to +105°C
 Contact Resistance : 20mΩ Max
 Insulation Resistance : 1000MΩ Min
 Withstanding Voltage : AC 500V
 Material:
 Insulator : Polyester (UL94V-0)
 Standard: PA6T/LCP
 Contact: Bronze
 Plating : Au or Sn Over 50u" Ni

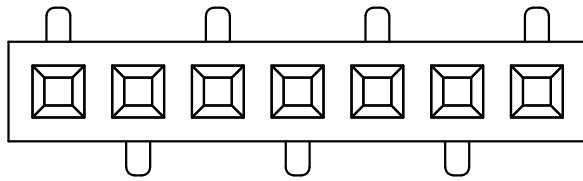
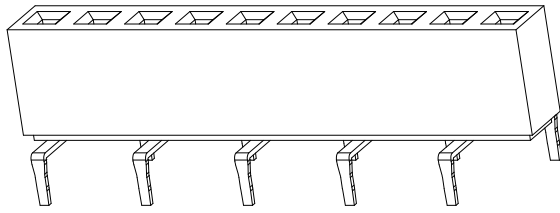

Type 1

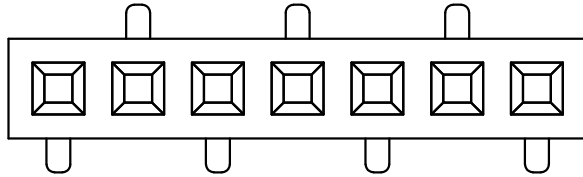

Type 2

H
4.0
4.3
4.6

Pin数	尺寸A	尺寸B
1x2	2.0	4.5
1x3	4.0	6.5
1x4	6.0	8.5
1x5	8.0	10.5
1x6	10.0	12.5
1x7	12.0	14.5
1x8	14.0	16.5
1x9	16.0	18.5
1x10	18.0	20.5
1x11	20.0	22.5
1x12	22.0	24.5
1x13	24.0	26.5
1x14	26.0	28.5
1x15	28.0	30.5
1x16	30.0	32.5
1x17	32.0	34.5
1x18	34.0	36.5
1x19	36.0	38.5
1x20	38.0	40.5
1x21	40.0	42.5
1x22	42.0	44.5
1x23	44.0	46.5
1x24	46.0	48.5
1x25	48.0	50.5
1x26	50.0	52.5
1x27	52.0	54.5
1x28	54.0	56.5
1x29	56.0	58.5
1x30	58.0	60.5
1x31	60.0	62.5
1x32	62.0	64.5
1x33	64.0	66.5
1x34	66.0	68.5
1x35	68.0	70.5
1x36	70.0	72.5
1x37	72.0	74.5
1x38	74.0	76.5
1x39	76.0	78.5
1x40	78.0	80.5

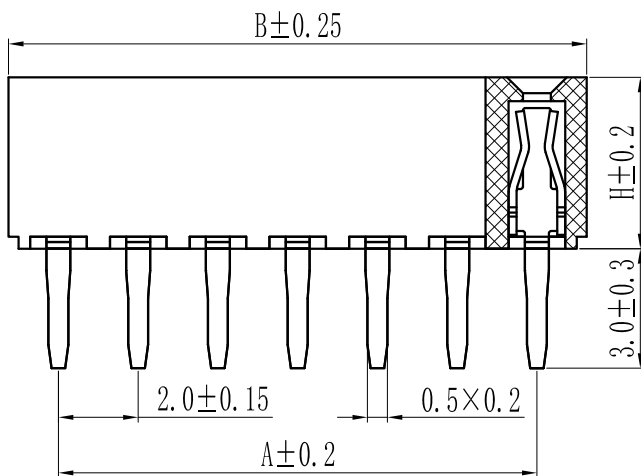

PCB LAYOUT

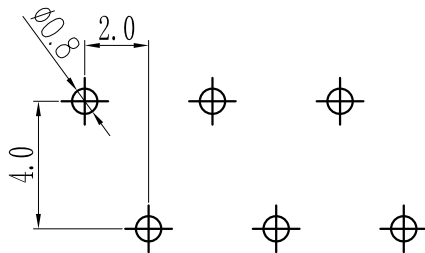
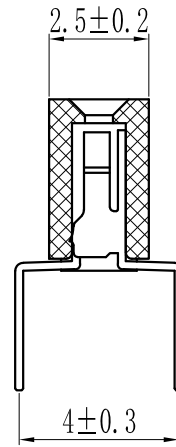

Type 1

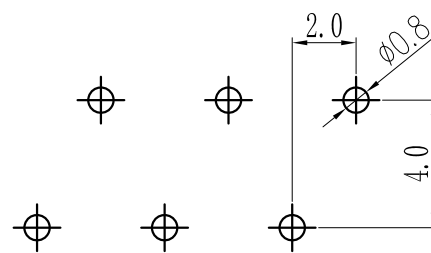

Type 2

	GENERAL TOLERANCES		SCALE: 1:1	NAME	DATE	深圳市思拓展电子有限公司 SHENZHEN SINOTOP ELECTRONICS CO., LTD 公司网址: www.szsituo.cn 公司电话: 0755-23765350 邮 箱: 2850175982@qq.com 公司传真: 0755-23765341	PART. NO: ST-FH-200-0078
	LINEAR	ANGLES					
UNIT: MM	0.00 ± 0.20	X° ± 3°	DESIGNER			TITLE: Pitch 2.0mm Female Header, Single Row, Plastic Height Hmm, Bottom Entry Type (U)	DWG. NO:
SIZE: A4	0.000 ± 0.10	X° X' ± 2°	DRAWN	肖坤权	2017.06.16	REV: A0	SHEET: 1/1

A B C D E F G H