

仅供参考

REV.	REVISION RECORD	DATE
A0	新图面发行	2017.06.16

Specification:  
 Current Rating : 1AMP  
 Temperature Range : -40°Cto+105°C  
 Contact Resistance : 20mΩ Max  
 Insulation Resistance : 500MΩ Min  
 Withstanding Voltage : AC 500V  
 Material:  
 Insulator : Polyester (UL94V-0)  
 Standard:PBT/PA6T/LCP  
 Contact: Brass  
 Plating : Au or Sn Over 50u" Ni

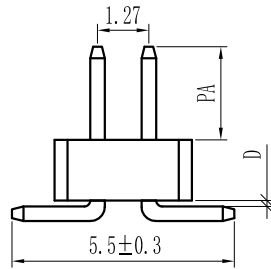
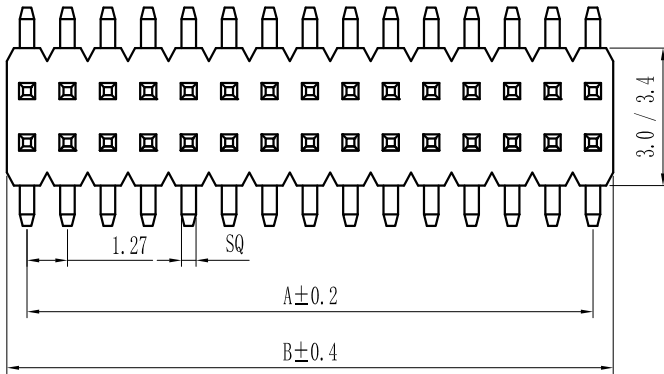
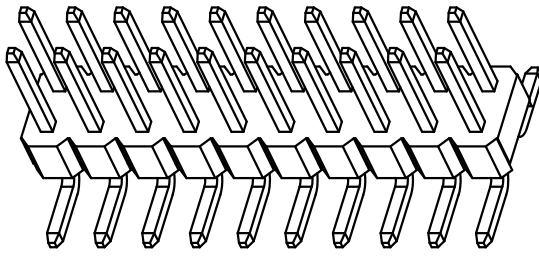

SQ
0.40
0.46

Pin数	尺寸A	尺寸B
2x1	-	1.27
2x2	1.27	2.54
2x3	2.54	3.81
2x4	3.81	5.08
2x5	5.08	6.35
2x6	6.35	7.62
2x7	7.62	8.89
2x8	8.89	10.16
2x9	10.16	11.43
2x10	11.43	12.70
2x11	12.70	13.97
2x12	13.97	15.24
2x13	15.24	16.51
2x14	16.51	17.78
2x15	17.78	19.05
2x16	19.05	20.32
2x17	20.32	21.59
2x18	21.59	22.86
2x19	22.86	24.13
2x20	24.13	25.40
2x21	25.40	26.67
2x22	26.67	27.94
2x23	27.94	29.21
2x24	29.21	30.48
2x25	30.48	31.75
2x26	31.75	33.02
2x27	33.02	34.29
2x28	34.29	35.56
2x29	35.56	36.83
2x30	36.83	38.10
2x31	38.10	39.37
2x32	39.37	40.64
2x33	40.64	41.91
2x34	41.91	43.18
2x35	43.18	44.45
2x36	44.45	45.72
2x37	45.72	46.99
2x38	46.99	48.26
2x39	48.26	49.53
2x40	49.53	50.80
2x41	50.80	52.07
2x42	52.07	53.34
2x43	53.34	54.61
2x44	54.61	55.88
2x45	55.88	57.15
2x46	57.15	58.42
2x47	58.42	59.69
2x48	59.69	60.96
2x49	60.96	62.23
2x50	62.23	63.50

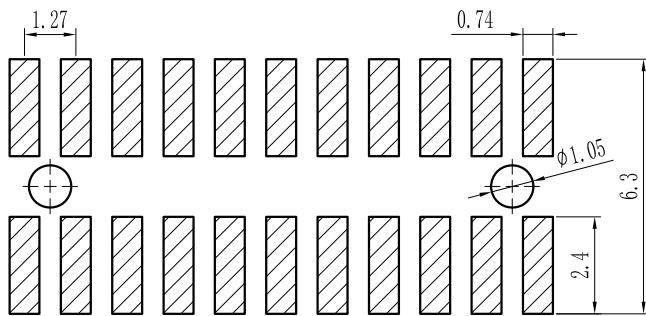
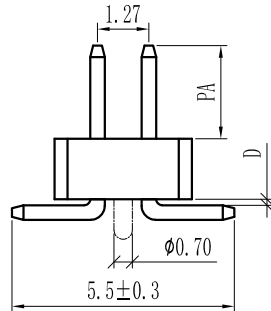
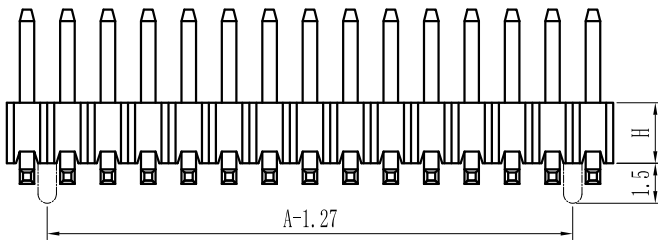

PCB LAYOUT

8	GENERAL TOLERANCES		SCALE: 1:1	NAME	DATE	 深圳市思拓展电子有限公司 SHENZHEN SINOTOP ELECTRONICS CO.,LTD 公司地址: www.szsituo.cn      公司电话: 0755-23765350 邮 箱: 2850175982@qq.com      公司传真: 0755-23765341	PART. NO: ST-PH-127-0030	
	UNIT: MM	0.00±0.20	APPROVED				DWG. NO:	
	SIZE: A4	0.000±0.10	DESIGNER				TITLE: Pitch1.27mm Pin Header, Single Plastic, Dual Row, SMT Type	REV: A0
			DRAWN	肖坤权	2017.06.16			SHEET: 1/1