

仅供参考

REV.	REVISION RECORD	DATE
A0	新图面发行	2017. 06. 16

主要技术参数
Main Specifications

线数 (poles): 2 to 20P
 额定电流 (Current rating): 1.0A AC, DC
 额定电压 (Voltage rating): 50V AC, DC
 温度范围 (Temperature range): -25°C to +85°C
 接触电阻 Contact resistance: $\leq 20m\Omega$
 绝缘电阻 (Insulation resistance): $\geq 100m\Omega$
 耐电压 (Withstand voltage): 500V AC/minute
 适用线规 (Applicable wire): AWG #32 to #28

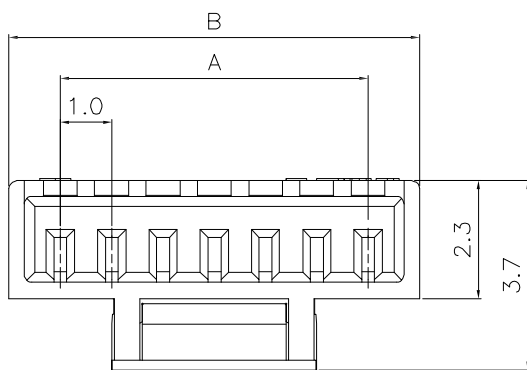
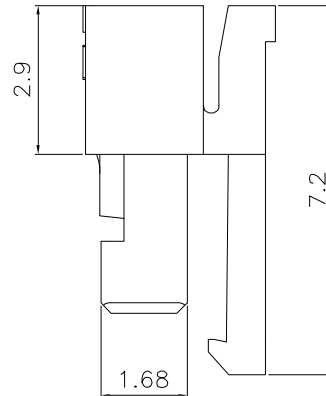
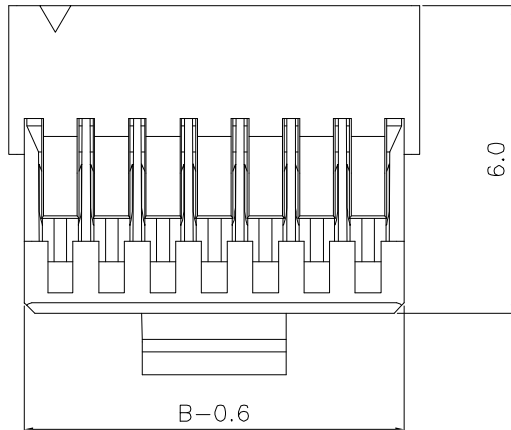

Poles	Dimensions mm	
	A	B
2	1.0	3.0
3	2.0	4.0
4	3.0	5.0
5	4.0	6.0
6	5.0	7.0
7	6.0	8.0
8	7.0	9.0
9	8.0	10.0
10	9.0	11.0
11	10.0	12.0
12	11.0	13.0
13	12.0	14.0
14	13.0	15.0
15	14.0	16.0
16	15.0	17.0
17	16.0	18.0
18	17.0	19.0
19	18.0	20.0
20	19.0	21.0

1	胶壳 (HOUSING)	PBT UL94V-0	1	White (白色)
序号	名称/料号	材料	数量	附注

	GENERAL TOLERANCES		SCALE: 1:1	NAME	DATE	深圳市思拓展电子有限公司 SHENZHEN SINOTOP ELECTRONICS CO., LTD 公司网址: www.szstuo.cn 公司电话: 0755-23765350 邮 箱: 2850175982@qq.com 公司传真: 0755-23765341	PART. NO:
	LINEAR	ANGLES	APPROVED				ST-WF-100-003Y2
	0.0±0.30	X° REF±6°	DESIGNER				DWG. NO:
	UNIT: MM	0.00±0.20	X° ±3°	DRAWN	肖坤权		2017. 06. 16
SIZE: A4	0.000±0.10	X° X'±2°					REV: A0 SHEET: 1/1

仅供参考

REV.	REVISION RECORD	DATE
A0	新图面发行	2017.06.16

主要技术参数
Main Specifications

线数 (poles): 2 to 20P
 额定电流 (Current rating): 1.0A AC, DC
 额定电压 (Voltage rating): 50V AC, DC
 温度范围 (Temperature range): -25°C to +85°C
 接触电阻 (Contact resistance): ≤20mΩ
 绝缘电阻 (Insulation resistance): ≥100mΩ
 耐电压 (Withstand voltage): 500V AC/minute
 适用线规 (Applicable wire): AWG #32 to #28

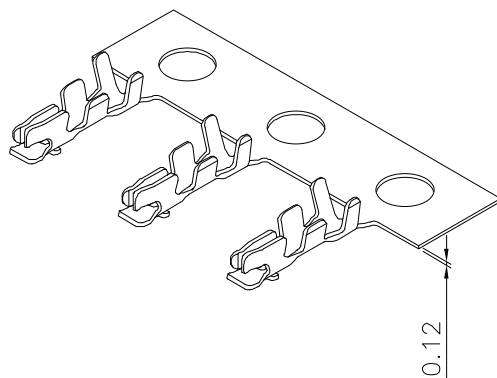
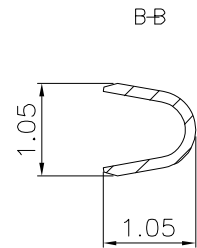
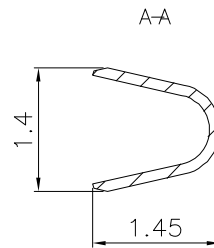
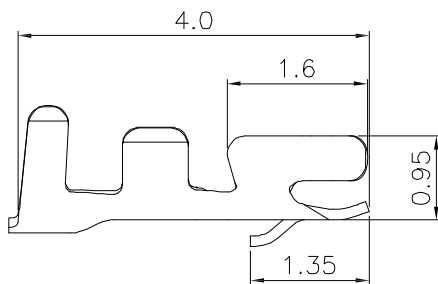
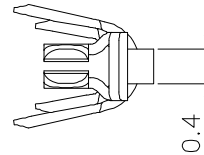
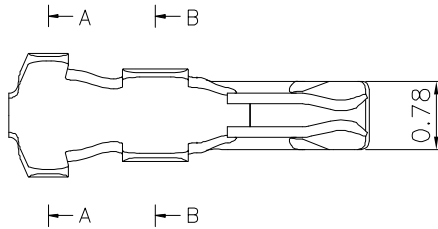

1	Terminal	Phos Bronze tin 磷青铜镀锡		
序号	名称/料号	材料	数量	附注

	GENERAL TOLERANCES		SCALE: 1:1	NAME	DATE	深圳市思拓展电子有限公司 SHENZHEN SINOTOP ELECTRONICS CO., LTD 公司网址: www.szstuo.cn 公司电话: 0755-23765350 邮箱: 2850175982@qq.com 公司传真: 0755-23765341	PART. NO: ST-WF-100-003T
	LINEAR	ANGLES	APPROVED				DWG. NO:
UNIT: MM	0.0±0.30	X° REF±6°	DESIGNER			TITLE: 1.0mmPITCH TERMINAL	REV: A0
SIZE: A4	0.000±0.10	X° X'±2°	DRAWN	肖坤权	2017.06.16		SHEET: 1/1