

仅供参考

REV.	REVISION RECORD	DATE
A0	新图面发行	2017.06.16

主要技术参数 Main Specifications

- 线 数 (Poles): 02 to 20
- 接触电阻 (Contact resistance): $\leq 20m\Omega$
- 绝缘电阻 (Insulation resistance): $\geq 100M\Omega$
- 额定电压 (Rated voltage): 50V AC DC
- 额定电流 (Rated current): 1.0A AC DC
- 耐 电压 (Withstand Voltage): 500V AC/minute
- 温度范围 (Temperature Range): $-25^{\circ}C \sim +105^{\circ}C$

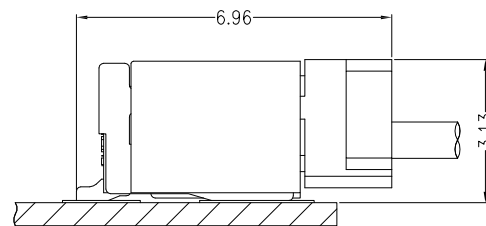
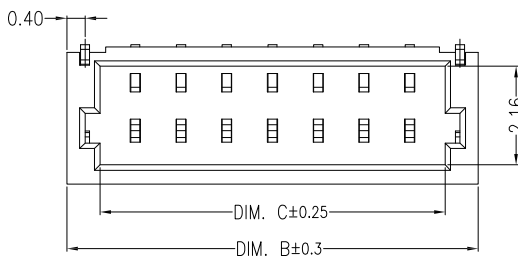
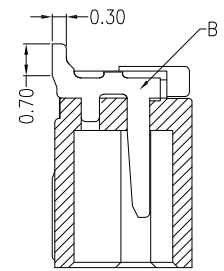
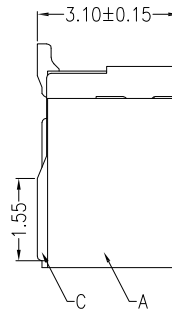
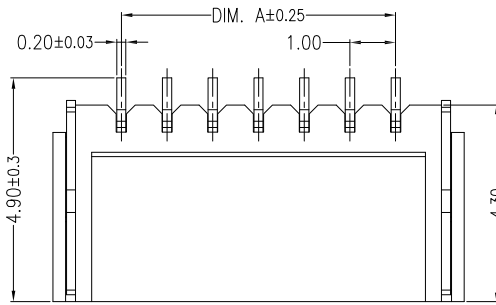
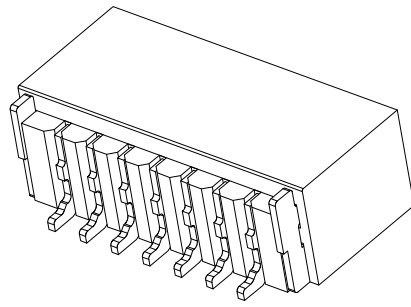

Assembly Layout

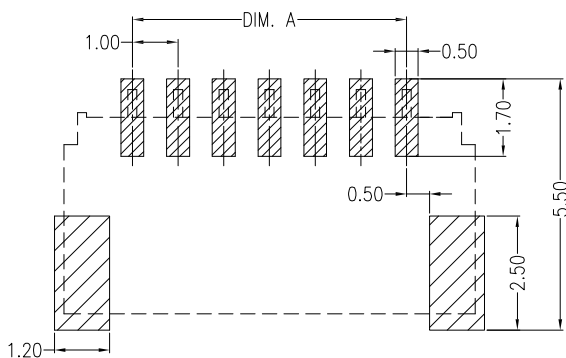

Recommend PCB Layout

Circuit	Dimensions (mm)		
	DIM. A	DIM. B	DIM. C
02	1.00	4.00	2.45
03	2.00	5.00	3.45
04	3.00	6.00	4.45
05	4.00	7.00	5.45
06	5.00	8.00	6.45
07	6.00	9.00	7.45
08	7.00	10.00	8.45
09	8.00	11.00	9.45
10	9.00	12.00	10.45
11	10.00	13.00	11.45
12	11.00	14.00	12.45
13	12.00	15.00	13.45
14	13.00	16.00	14.45
15	14.00	17.00	15.45
16	15.00	18.00	16.45
20	19.00	22.00	20.45

C	SOLDER TAB	2 PCS	PHOSPHORBRONZF	MATTE Sn-plated
B	CONTACT	2~20PCS	PHOSPHORBRONZE	MATTE Sn /GOLD-plated
A	PEDESTAL	1 PCS	LCP	UL 94V-0, COLOR:BEIGE
ITEM	COMPONENT	Q'TY	MATERIAL	FINISH

	GENERAL TOLERANCES		SCALE: 1:1	NAME	DATE
	LINEAR	ANGLES			
	0.0±0.30	X° REF±6°	APPROVED		
UNIT: MM	0.00±0.20	X° ±3°	DESIGNER		
SIZE: A4	0.000±0.10	X° X'±2°	DRAWN	肖坤权	2017.06.16

深圳市思拓展电子有限公司
 SHENZHEN SINOTOP ELECTRONICS CO.,LTD
 公司网址: www.szsituo.cn 公司电话: 0755-23765350
 邮 箱: 2850175982@qq.com 公司传真: 0755-23765341

TITLE:
1.0mmPITCH 90° WAFER SMT TYPE

PART. NO:	ST-WF-100-001AWR	
DWG. NO:		
REV:	A0	SHEET: 1/1