

仅供参考

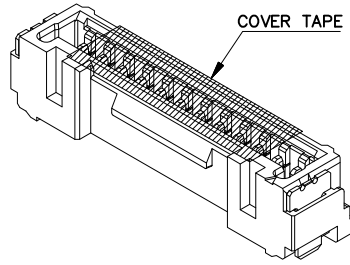

REV.	REVISION RECORD	DATE
A0	新图面发行	2017.06.16

主要技术参数 Main Specifications

- 线数 (Poles): 02 to 16
- 接触电阻 (Contact resistance): $\leq 20m\Omega$
- 绝缘电阻 (Insulation resistance): $\geq 500M\Omega$
- 额定电压 (Rated voltage): 150V AC DC
- 额定电流 (Rated current): 1.0A AC DC
- 耐电压 (Withstand Voltage): 500V AC/minute
- 温度范围 (Temperature Range): $-25^{\circ}C \sim +85^{\circ}C$

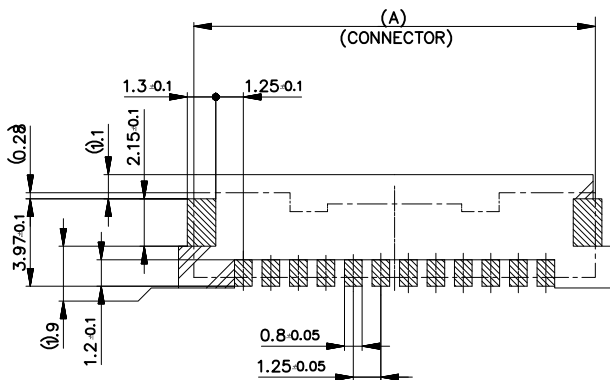
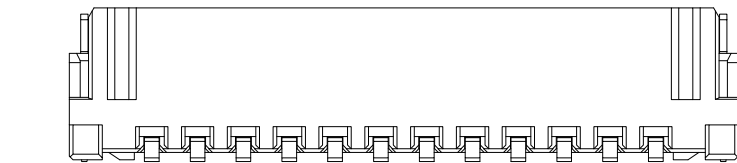
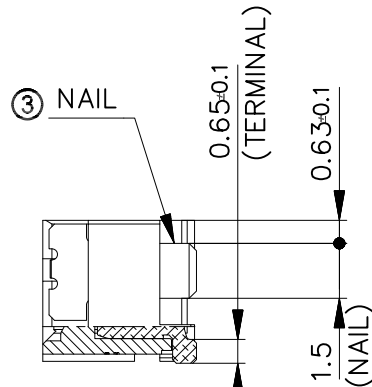
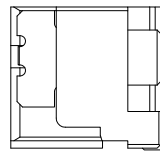
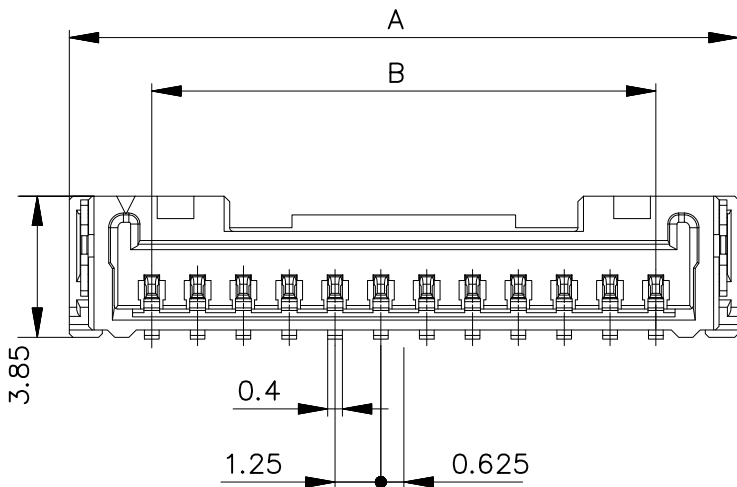
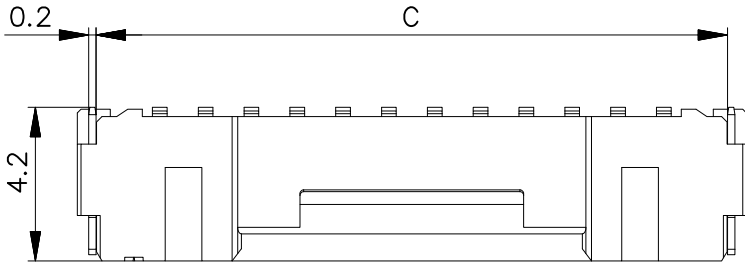

22.20	18.75	23.25	16
20.95	17.50	22.00	15
19.70	16.25	20.75	14
18.45	15.00	19.50	13
17.20	13.75	18.25	12
15.95	12.50	17.00	11
14.70	11.25	15.75	10
13.45	10.00	14.50	9
12.20	8.75	13.25	8
10.95	7.50	12.00	7
9.70	6.25	10.75	6
8.45	5.00	9.50	5
7.20	3.75	8.25	4
5.95	2.50	7.00	3
4.70	1.25	5.75	2
C	B	A	CIRCUIT

NO.	PART	MATERIAL
①	HOUSING	PA, GLASS FILLED, UL94 V-0, COLOR: BEIGE
②	TERMINAL	BRASS GOLD PLATING
③	NAIL	BRASS MATTE TIN PLATING
④	COVER TAPE	PA

	GENERAL TOLERANCES		SCALE: 1:1	NAME	DATE
	LINEAR	ANGLES			
UNIT: MM	0.0 ± 0.30	X° REF ± 6°	APPROVED		
SIZE: A4	0.000 ± 0.10	X° X' ± 2°	DESIGNER		
			DRAWN	肖坤权	2017.06.16

深圳市思拓展电子有限公司
 SHENZHEN SINOTOP ELECTRONICS CO., LTD
 公司网址: www.szstuo.cn 公司电话: 0755-23765350
 邮 箱: 2850175982@qq.com 公司传真: 0755-23765341

TITLE:
1. 2.5mm PITCH 180° WAFER SMT TYPE

PART NO:	ST-WF-125-006AWV
DWG NO:	
REV:	A0
SHEET:	1/1

1
2
3
4
5
6
7
8

1
2
3
4
5
6
7
8

A B C D E F G H